

**FRAMEPORT
AMERICA**



July, 2024



Table of Contents

PRIMED DOORS



Shaker Style Flat Panel Doors
Pages 4 - 7



Fire Doors
Pages 8 & 9



Toscana Colonial Doors
Pages 10 & 11



French Ovolo Doors
Pages 12 & 13



French Shaker Doors
Pages 14 & 15



Mirror/Panel Doors
Pages 16 & 17



Fixed Louver Doors
Pages 18 & 19



Barn Doors
Pages 20 & 21



Bifold Doors
Pages 22 - 24

Table of Contents

CLEAR PINE DOORS



Colonial Doors
Pages 25 - 27



French Ovolo Doors
Pages 28 & 29



Fixed Louver Doors
Pages 30 & 31



Bifold Doors
Pages 32 - 33



Wood Shims
Page 39

KNOTTY PINE DOORS



Colonial Doors
Pages 34 & 35



Barn Doors
Page 36 & 37



Bifold Doors
Page 38

Shaker Flat Panel

PRIMED DOORS



Features:

- A complete line of Shaker style doors in a broad range of panel configurations
- Environmentally friendly, FSC Certified
- 5-year limited warranty
- All doors are full and square and polyolefin wrapped



- 1 Top & bottom of door is factory-sealed for reliable performance
- 2 Shaker sticking
- 3 Superior priming – five coats with sanding between coats
- 4 Panels are primed prior to assembly

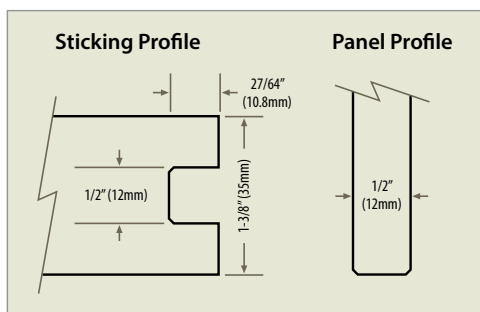

Panel edges are kerfed and squeezed during panel insertion, allowing them to expand and grip the inside door frame, eliminating rattling.

Shaker Flat Panel

PRIMED DOORS



1 Panel



2 Panel



Craftsman



3 Panel



5 Panel

Primed Shaker Door 6'8" x 1-3/8"

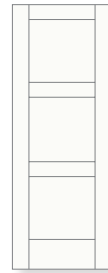
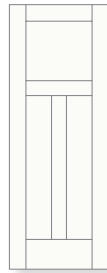
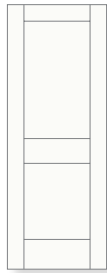

Size	Quantity Per Pallet	1 Panel Primed	2 Panel Primed	Craftsman Primed	3 Panel Primed	5 Panel Primed
		Item #	Item #	Item #	Item #	Item #
1/4 x 6/8 x 1-3/8	16	3367940	3368033	-	-	-
1/6 x 6/8 x 1-3/8	16	3372871	3372898	3318117	3372901	3372910
1/8 x 6/8 x 1-3/8	16	3367975	3349500	-	-	-
1/10 x 6/8 x 1-3/8	16	3367983	3373002	-	-	-
2/0 x 6/8 x 1-3/8	32	3349551	3349616	3349675	3349799	3349730
2/2 x 6/8 x 1-3/8	32	3349535	3349519	-	-	-
2/4 x 6/8 x 1-3/8	32	3349560	3349624	3349683	3349802	3349748
2/6 x 6/8 x 1-3/8	32	3349578	3349632	3349691	3349810	3349756
2/8 x 6/8 x 1-3/8	32	3349586	3349640	3349705	3349829	3349764
2/10 x 6/8 x 1-3/8	32	3349527	3349667	3349950	3349993	3349977
3/0 x 6/8 x 1-3/8	32	3349594	3349659	3349713	3349837	3349772

Shaker Flat Panel

PRIMED DOORS

Primed Shaker Door 8'0" x 1-3/8"

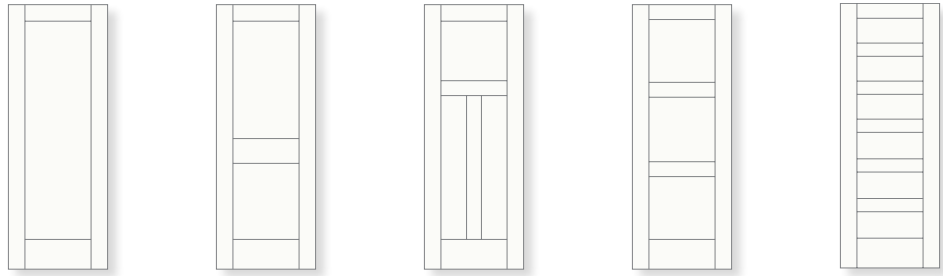

Size	Quantity Per Pallet	1 Panel Primed	2 Panel Primed	Craftsman Primed	3 Panel Primed	6 Panel Primed
		Item #	Item #	Item #	Item #	Item #
1/4 x 8/0 x 1-3/8	16	3349926	3338924	-	-	-
1/6 x 8/0 x 1-3/8	16	3372880	3372936	3365395	3372944	3397360
1/8 x 8/0 x 1-3/8	16	3372979	3372995	-	-	-
1/10 x 8/0 x 1-3/8	16	3373037	3373045	-	-	-
2/0 x 8/0 x 1-3/8	32	3349853	3338967	3367711	3339106	3397394
2/2 x 8/0 x 1-3/8	32	3349900	3338975	-	-	-
2/4 x 8/0 x 1-3/8	32	3349861	3338983	3367738	3339122	3397416
2/6 x 8/0 x 1-3/8	32	3349870	3338991	3367746	3339130	3397424
2/8 x 8/0 x 1-3/8	32	3349888	3339009	3367754	3339149	3397432
2/10 x 8/0 x 1-3/8	32	3349918	3339017	3367762	-	-
3/0 x 8/0 x 1-3/8	32	3349896	3339025	3367770	3339157	3397459

Primed Shaker Door 6'8" and 8'0" x 1-3/4"

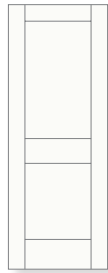

Size	Quantity Per Pallet	2 Panel Primed
		Item #
1/6 x 6/8 x 1-3/4	16	3145182
2/0 x 6/8 x 1-3/4	25	3145212
2/4 x 6/8 x 1-3/4	25	3145239
2/6 x 6/8 x 1-3/4	25	3145247
2/8 x 6/8 x 1-3/4	25	3145255
2/10 x 6/8 x 1-3/4	25	3145263
3/0 x 6/8 x 1-3/4	25	3145271
1/6 x 8/0 x 1-3/4	16	3365492
2/0 x 8/0 x 1-3/4	25	3260500
2/4 x 8/0 x 1-3/4	25	3260526
2/6 x 8/0 x 1-3/4	25	3260534
2/8 x 8/0 x 1-3/4	25	3260542
2/10 x 8/0 x 1-3/4	25	3260550
3/0 x 8/0 x 1-3/4	25	3260569

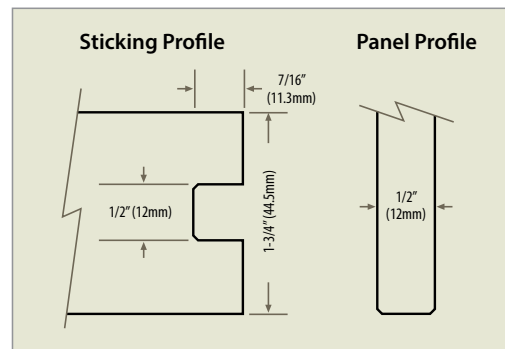



Fire – 20 Minute Flat Panel

PRIMED DOORS

Features:

- Frameport 20 Minute Fire Door Slabs are certified through Intertek's Building Products Certification Program as compliant with UL 10C Standard for Positive Pressure Fire Tests of Door Assemblies
- Flat Panel Doors are listed with Intertek WH under Specification # 51014 – 20 Minute without Hose Stream (US only)
- All Frameport Fire Doors are constructed with fire-resistant gypsum panels & intumescent ribbon to seal joints when exposed to open flame



Intertek's Warnock Hersey (WH) Mark is North America's leading product safety and performance mark for fire doors.

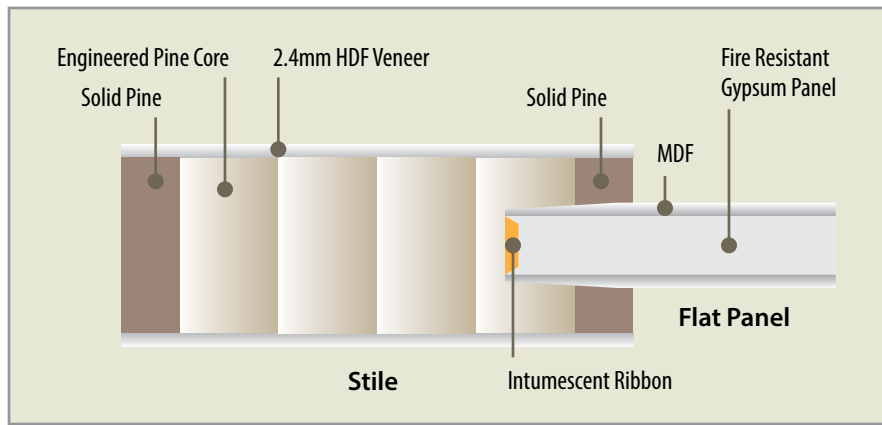

- 1-3/4" thickness
- Fire doors feature shaker-style flat panels to match standard interior shaker doors, allowing consistency of design throughout the home (component dimensions may vary, see specification drawings for details)
- Per NFPA 80 Standard for Fire Doors and Other Opening Protectives, maximum trimming allowed from the bottom of the doors is 3/4"
- Frameport Fire Door Slabs can be added to existing Fire Door System certifications – consult your certifying body for instructions
- Environmentally friendly, FSC certified
- All doors are TSCA compliant
- 5-year limited warranty

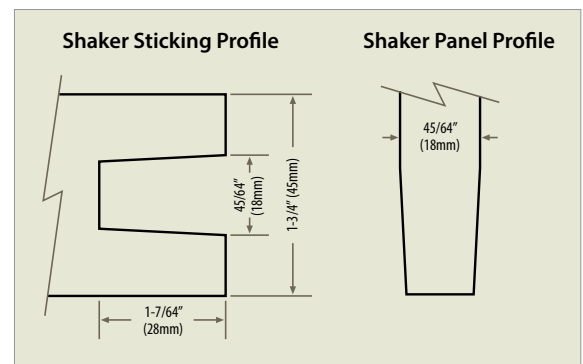

Fire – 20 Minute Flat Panel

PRIMED DOORS



1 Panel



2 Panel



Craftsman



3 Panel



5 Panel

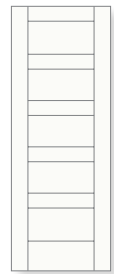
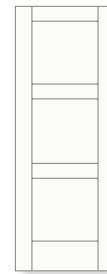
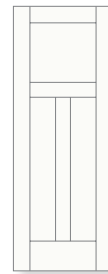
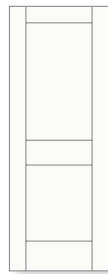
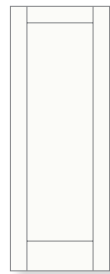

Size	Quantity Per Pallet	1 Panel Primed	2 Panel Primed	Craftsman Primed	3 Panel Primed	5 Panel Primed
		Item #	Item #	Item #	Item #	Item #
2/8 x 6/8 x 1-3/4	12	3146405	3146502	3146600	3146707	3146804
3/0 x 6/8 x 1-3/4	12	3146421	3146529	3146626	3146723	3146820

* All fire doors are full & square

Toscana Colonial

PRIMED DOORS – 1-3/4" Raised Panel



Features:

- 10.5" bottom rail – ADA compliant
- Environmentally friendly, FSC Certified
- All doors are TSCA compliant
- 5-year limited warranty

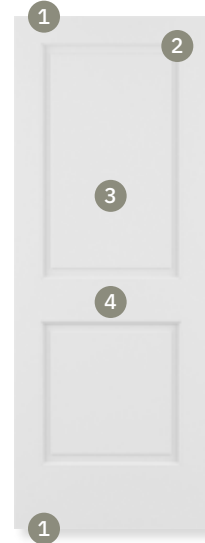

- 1 Top & bottom of door is factory-sealed for reliable performance
- 2 Ovolo sticking
- 3 Superior priming – five coats with sanding between coats
- 4 Panels are primed prior to assembly

Toscana Colonial

PRIMED DOORS – 1-3/4" Raised Panel

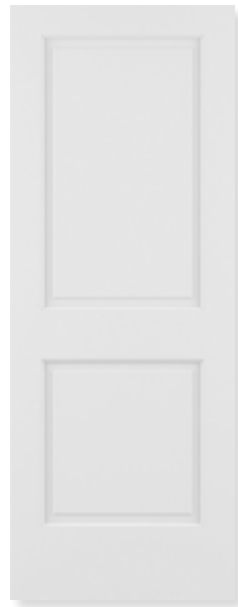
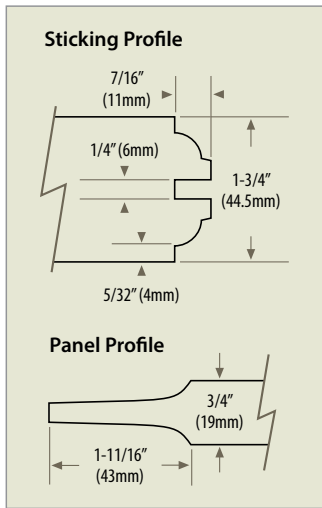

2 Panel
Colonial
Primed

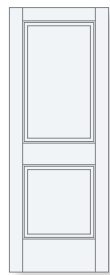

Size	Quantity Per Pallet	2 Panel Colonial Ovolo Sticking Primed
		Item #
1/4 x 6/8 x 1-3/4	16	0000000
1/6 x 6/8 x 1-3/4	16	0000000
1/8 x 6/8 x 1-3/4	16	0000000
2/0 x 6/8 x 1-3/4	25	0000000
2/4 x 6/8 x 1-3/4	25	0000000
2/6 x 6/8 x 1-3/4	25	0000000
2/8 x 6/8 x 1-3/4	25	0000000
2/10 x 6/8 x 1-3/4	25	0000000
3/0 x 6/8 x 1-3/4	25	0000000

Size	Quantity Per Pallet	2 Panel Colonial Ovolo Sticking Primed
		Item #
1/4 x 8/0 x 1-3/4	16	0000000
1/6 x 8/0 x 1-3/4	16	0000000
1/8 x 8/0 x 1-3/4	16	0000000
2/0 x 8/0 x 1-3/4	25	0000000
2/4 x 8/0 x 1-3/4	25	0000000
2/6 x 8/0 x 1-3/4	25	0000000
2/8 x 8/0 x 1-3/4	25	0000000
2/10 x 8/0 x 1-3/4	25	0000000
3/0 x 8/0 x 1-3/4	25	0000000

French Ovolo

PRIMED DOORS



Features:

- 1-3/8" interior wood door
- True divided lites
- Environmentally friendly, FSC Certified
- 5-year limited warranty
- All doors are full and square and polyolefin wrapped



- 1 Top & bottom of door is factory-sealed for reliable performance
- 2 Pre-masked film for easy clean up after finishing
- 3 True divided lite with tempered glass for safety
- 4 Superior priming – five coats with sanding between coats
- 5 Panels are primed prior to assembly

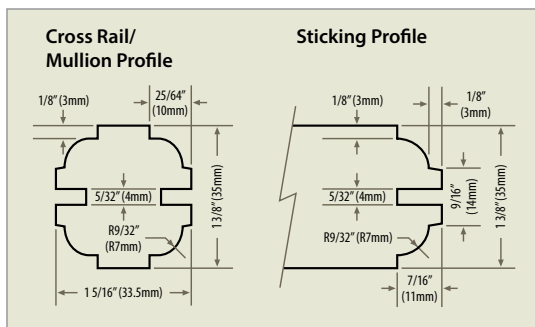

French Ovolo

PRIMED DOORS



1 Lite
Clear Glass



10 Lite
Clear Glass



15 Lite
Clear Glass



12 Lite
Clear Glass



18 Lite
Clear Glass

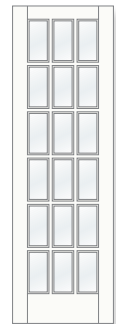
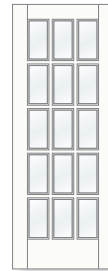

Size	Quantity Per Pallet	1 Lite Clear Glass Primed	10 Lite Clear Glass Primed	15 Lite Clear Glass Primed	12 Lite Clear Glass Primed	18 Lite Clear Glass Primed
		Item #	Item #	Item #	Item #	Item #
1/6 x 6/8 x 1-3/8	16	-	3232875	-	-	-
2/0 x 6/8 x 1-3/8	32	3243966	3232905	-	-	-
2/4 x 6/8 x 1-3/8	32	3243982	3232921	-	-	-
2/6 x 6/8 x 1-3/8	32	3243990	3232930	3233073	-	-
2/8 x 6/8 x 1-3/8	32	3244008	3232948	3233081	-	-
3/0 x 6/8 x 1-3/8	32	3244024	3232964	3233103	-	-
2/0 x 8/0 x 1-3/8	32	3342620	-	-	3232999	-
2/4 x 8/0 x 1-3/8	32	3342646	-	-	3233014	-
2/6 x 8/0 x 1-3/8	32	3342654	-	-	3233022	3233154
2/8 x 8/0 x 1-3/8	32	3342662	-	-	3233030	3233120
3/0 x 8/0 x 1-3/8	32	3342689	-	-	3233057	3233170

All lites are film protected

French Shaker

PRIMED DOORS



Features:

- 1-3/8" interior wood door
- Environmentally friendly, FSC Certified
- 5-year limited warranty
- All doors are full and square and polyolefin wrapped



- 1 Top & bottom of door is factory-sealed for reliable performance
- 2 Shaker sticking
- 3 Superior priming – five coats with sanding between coats
- 4 Panels are primed prior to assembly

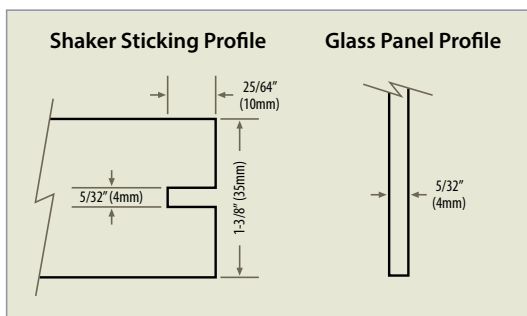

French Shaker

PRIMED DOORS



1 Lite
Clear Glass



1 Lite
Frosted Glass



3 Lite
Frosted Glass



5 Lite
Frosted Glass

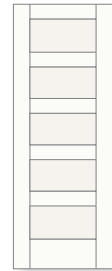
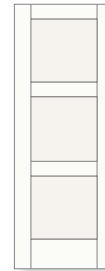
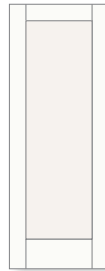
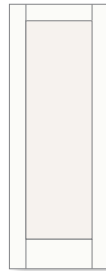

Size	Quantity Per Pallet	1 Lite Clear Glass Primed	1 Lite Frosted Glass Primed	3 Lite Frosted Glass Primed	5 Lite Frosted Glass Primed
		Item #	Item #	Item #	Item #
2/0 x 6/8 x 1-3/8	32	3144690	3384977	-	-
2/6 x 6/8 x 1-3/8	32	3144720	3385000	3367444	3369480
2/8 x 6/8 x 1-3/8	32	0000000	3385019	3367452	3369498
3/0 x 6/8 x 1-3/8	32	3144755	3385035	3367479	3369510
2/0 x 8/0 x 1-3/8	32	3144860	-	-	-
2/6 x 8/0 x 1-3/8	32	3144895	-	-	-
3/0 x 8/0 x 1-3/8	32	3144925	-	-	-

All lites are film protected

1-Lite Clear Shaker 32x80x1-3/8" Primed 266.68

Mirror/Panel

PRIMED DOORS

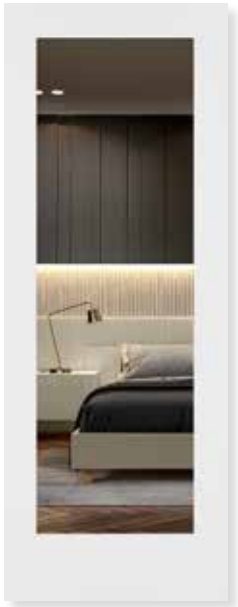

Mirror/Panel
Primed

Features:

- Feature safety mirror glass backed with polyethylene film
 - Compliant with the ANSI Z97.1 standards for safety glazing materials
 - Environmentally friendly, FSC Certified
 - All doors are TSCA compliant
 - 5-year limited warranty
- 1 Top & bottom of door is factory-sealed for reliable performance
 - 2 Superior priming – five coats with sanding between coats
 - 3 Panels are primed prior to assembly

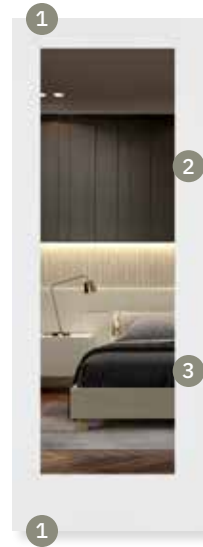

Size	Quantity Per Pallet	Mirror/Panel Primed Item #
1/6 x 6/8 x 1-3/8	16	3102050
2/0 x 6/8 x 1-3/8	32	3102084
2/4 x 6/8 x 1-3/8	32	3102106
2/6 x 6/8 x 1-3/8	32	3102114
2/8 x 6/8 x 1-3/8	32	3102122
3/0 x 6/8 x 1-3/8	32	3102149

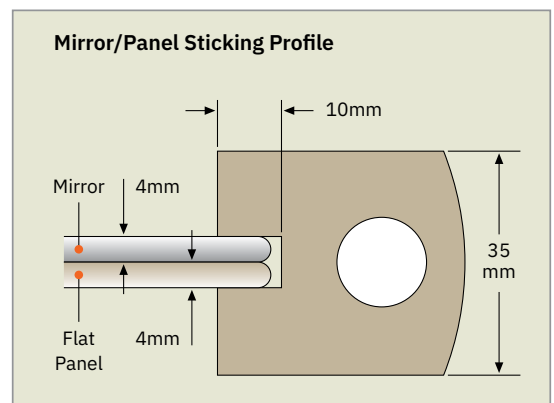



Fixed Louver

PRIMED DOORS



Features:

- 1-3/8" interior wood door
- Environmentally friendly, FSC Certified
- 5-year limited warranty
- All doors are full and square and polyolefin wrapped

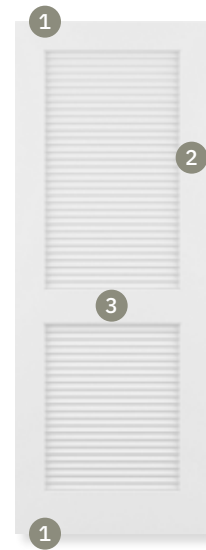

- 1 Top & bottom of door is factory-sealed for reliable performance
- 2 Superior priming – five coats with sanding between coats
- 3 Panels are primed prior to assembly



Fixed Louver

PRIMED DOORS

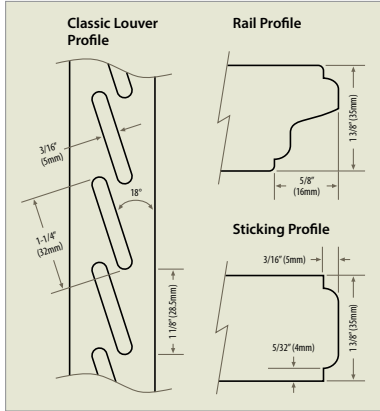

Classic Louver/Louver Primed



Plantation Louver/Louver Primed

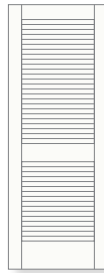
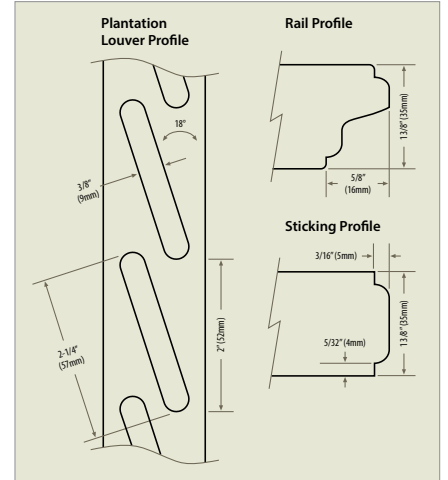

Size	Quantity Per Pallet	Classic Louver/Louver Primed Item #	Plantation Louver/Louver Primed Item #
1/6 x 6/8 x 1-3/8	16	3245543	3229165
2/0 x 6/8 x 1-3/8	32	3245578	3229190
2/4 x 6/8 x 1-3/8	32	3245594	3229211
2/6 x 6/8 x 1-3/8	32	3245608	3229220
2/8 x 6/8 x 1-3/8	32	3245616	3229238
2/10 x 6/8 x 1-3/8	32	3245624	0000000
3/0 x 6/8 x 1-3/8	32	3245632	3229254
1/6 x 8/0 x 1-3/8	16	3046036	-
2/0 x 8/0 x 1-3/8	32	3046060	-
2/4 x 8/0 x 1-3/8	32	3046087	-
2/6 x 8/0 x 1-3/8	32	3046095	-
2/8 x 8/0 x 1-3/8	32	3046109	-
3/0 x 8/0 x 1-3/8	32	3046125	-

Barn

PRIMED DOORS



Z Brace

Features:

- 1-3/8" interior wood door
 - Environmentally friendly, FSC Certified
 - 5-year limited warranty
 - All doors are full and square and polyolefin wrapped
- 1 Top & bottom of door is factory-sealed for reliable performance
 - 2 All barn doors have a routed channel along the bottom to fit the floor-mounted door guide
 - 3 Superior priming – five coats with sanding between coats
 - 4 Panels are primed prior to assembly



Hardware Options

Each kit includes:

- Track
- Straps
- Floor-Mounted Door Guide
- Stoppers
- Mounting Hardware



*Black
Bent-Strap
Hardware*



*Slate Grey
Straight-Strap
Hardware*

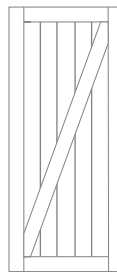

Size	Quantity Per Pallet	Z-Brace Primed
		Item #
		Barn Door Slabs
3/0 x 7/0 x 1-3/8	1	3159671
3/6 x 7/0 x 1-3/8	1	3159680
		Barn Door Hardware - 80" Track
Black Finish	1	9041675
Slate Grey Finish	1	9110574



Bifolds

PRIMED DOORS



Features:

- Pre-hinged, ready to install
- Track and hardware included
- Easy to install
- Environmentally friendly, FSC Certified
- 5-year limited warranty

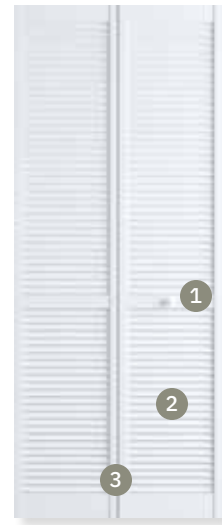

- 1 Knob, track and hardware included
- 2 Superior priming – five coats with sanding between coats
- 3 Panels are primed prior to assembly

*Johnson 1700 Series Hardware
included with 1-3/8" bifolds*

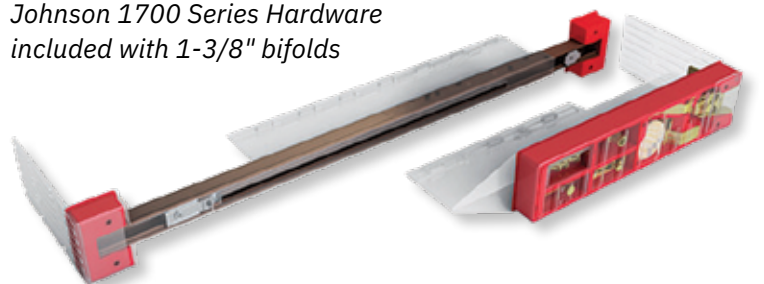

Bifolds

PRIMED DOORS



Classic
Louver/Louver
1-1/8"



Plantation
Louver/Louver
1-3/8"



Shaker
1 Panel
1-3/8"



Shaker
2 Panel
1-3/8"

Size 1-1/8" Width	Quantity Per Pallet	Classic Louver/Louver Item #
2/0 x 6/8 x 1-1/8	44	3287033
2/6 x 6/8 x 1-1/8	44	3287068
2/8 x 6/8 x 1-1/8	44	3287076
3/0 x 6/8 x 1-1/8	44	3287092
4/0 x 6/8 x 1-1/8	22	3114678
5/0 x 6/8 x 1-1/8	22	3114686
6/0 x 6/8 x 1-1/8	22	3114708

Size 1-3/8" Width	Quantity Per Pallet	Plantation Louver/Louver Item #	Shaker 1 Panel Item #	Shaker 2 Panel Item #
2/0 x 6/8 x 1-3/8	32	3111210	3283240	3288668
2/6 x 6/8 x 1-3/8	32	3111245	3283267	3288692
2/8 x 6/8 x 1-3/8	32	3111253	-	-
3/0 x 6/8 x 1-3/8	32	3111270	3283291	3288722
4/0 x 6/8 x 1-3/8	16	3114848	9315052	9315220
5/0 x 6/8 x 1-3/8	16	3114856	9315104	9315263
6/0 x 6/8 x 1-3/8	16	3114872	9315157	9315310

Bifolds

PREFINISHED WHITE DOORS



Classic
Louver/Louver
1-1/8"



Plantation
Louver/Louver
1-1/8"

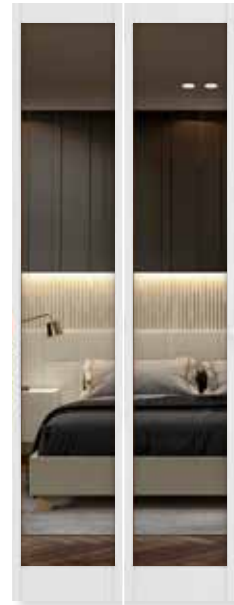

Mirror
1-1/8"

Size	Quantity Per Pallet	Classic Louver/Louver	Plantation Louver/Louver	Mirror
		Item #	Item #	Item #
2/0 x 6/8 x 1-1/8	44	3105075	3105431	3117014
2/6 x 6/8 x 1-1/8	44	3105083	3105440	3117030
2/8 x 6/8 x 1-1/8	44	-	-	-
3/0 x 6/8 x 1-1/8	44	3105091	3105458	3117065
4/0 x 6/8 x 1-1/8	22	9315225	9316293	9315381
5/0 x 6/8 x 1-1/8	22	9315249	9316320	9315440
6/0 x 6/8 x 1-1/8	22	9315273	9316374	9315492
2/0 x 8/0 x 1-1/8	44	-	3105466	-
2/6 x 8/0 x 1-1/8	44	-	3105474	-
3/0 x 8/0 x 1-1/8	44	-	3105482	-
4/0 x 8/0 x 1-1/8	22	-	9316398	-
5/0 x 8/0 x 1-1/8	22	-	9316422	-
6/0 x 8/0 x 1-1/8	22	-	9316446	-

Colonial

CLEAR PINE DOORS



Colonial

CLEAR PINE DOORS



Features:

- 1-3/8" interior wood door
- Suitable for staining or painting
- Environmentally friendly, FSC Certified
- 5-year limited warranty
- All doors are full and square and polyolefin wrapped



- 1 Top & bottom of door is factory-sealed for reliable performance
- 2 Double hip panel profiles for deeper, richer aesthetic
- 3 Full 3/4" thick panel reduces noise
- 4 Vertical grain for beautiful appearance and uniform finishing

Single Hip Profile

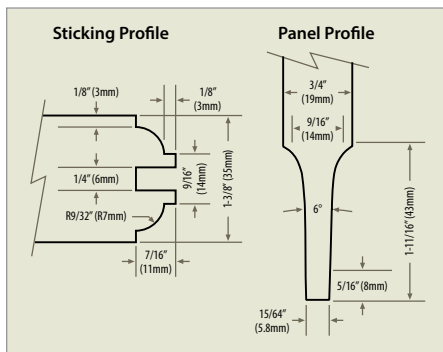

Double Hip Profile

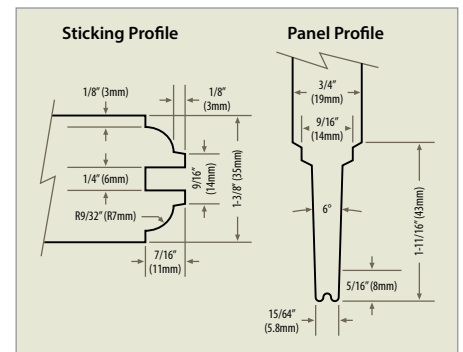

Colonial

CLEAR PINE DOORS



6 Panel
Single Hip



6 Panel
Double Hip



2 Panel
Double Hip
Square Top



2 Panel
Double Hip
Arch Top



2 Panel
Double Hip
Arch Top, V-Groove

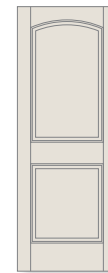
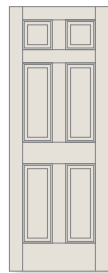

Size	Quantity Per Pallet	6 Panel Single Hip 3/4" Panel Clear Pine	6 Panel Double Hip 3/4" Panel Clear Pine	2 Panel Double Hip 3/4" Panel Clear Pine	2 Panel Double Hip Arch Top 3/4" Panel Clear Pine	2 Panel Double Hip Arch Top V-Groove 3/4" Panel Clear Pine
		Item #	Item #	Item #	Item #	Item #
1/6 x 6/8 x 1-3/8	16	0000000	3257215	3241327	3240061	3340171
2/0 x 6/8 x 1-3/8	32	0000000	3257240	3333868	3240096	3340201
2/4 x 6/8 x 1-3/8	32	0000000	3257266	3333884	3240118	3340228
2/6 x 6/8 x 1-3/8	32	0000000	3257274	3333892	3240126	3340236
2/8 x 6/8 x 1-3/8	32	0000000	3257282	3333906	3240134	3340244
3/0 x 6/8 x 1-3/8	32	0000000	3257304	3333922	3240150	3340260

* Three panel configuration

French Ovolo

CLEAR PINE DOORS



Features:

- 1-3/8" interior wood door
- True divided lites
- Suitable for staining or painting
- Environmentally friendly, FSC Certified
- 5-year limited warranty
- All doors are full and square and polyolefin wrapped

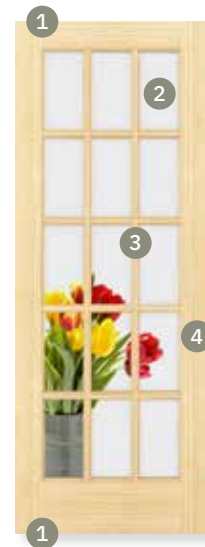

- 1 Top & bottom of door is factory-sealed for reliable performance
- 2 Pre-masked film for easy clean up after finishing
- 3 True divided lite with tempered glass for safety
- 4 Vertical grain for beautiful appearance and uniform finishing

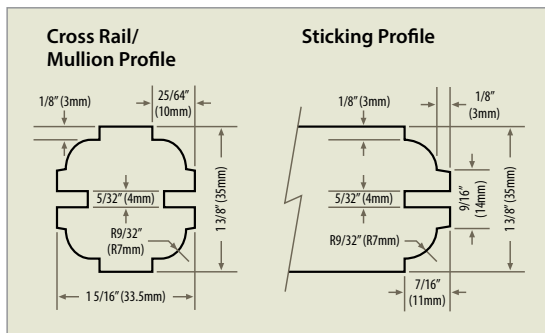

French Ovolo

CLEAR PINE DOORS



1 Lite
Clear Glass



1 Lite
Frosted Glass



Pantry
Frosted Glass



15 Lite
Clear Glass



Size	Quantity Per Pallet	1 Lite Clear Glass Clear Pine	1 Lite Frosted Glass Clear Pine	1 Lite Pantry Glass Clear Pine	15 Lite Clear Glass Clear Pine
		Item #	Item #	Item #	Item #
2/0 x 6/8 x 1-3/8	32	3226395	3317307	3317200	3226883*
2/4 x 6/8 x 1-3/8	32	3226417	3317323	3317226	-
2/6 x 6/8 x 1-3/8	32	3226425	3317331	3317234	3227260
2/8 x 6/8 x 1-3/8	32	3226433	3317340	3317242	3227278
3/0 x 6/8 x 1-3/8	32	3226450	3317366	-	3227294

All lites are film protected

*10-lite

Fixed Louver

CLEAR PINE DOORS



Features:

- 1-3/8" interior wood door
- Rich vertical grain suitable for staining or painting
- Environmentally friendly, FSC Certified
- 5-year limited warranty
- All doors are full and square and polyolefin wrapped

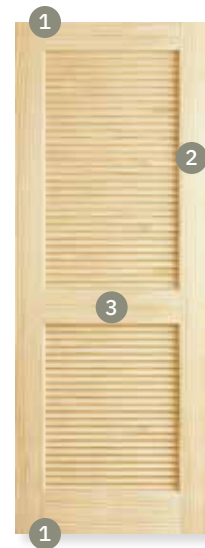

- 1 Top & bottom of door is factory-sealed for reliable performance
- 2 Vertical grain for beautiful appearance and uniform finishing
- 3 Triple-sanded, furniture-grade finish adds elegance and style



Fixed Louver

CLEAR PINE DOORS

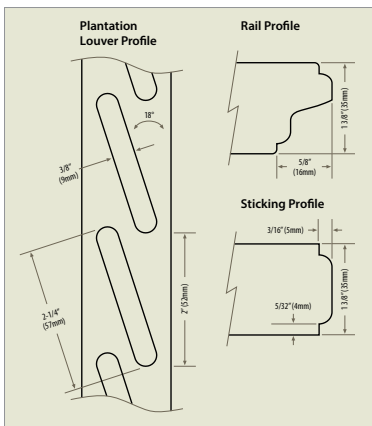
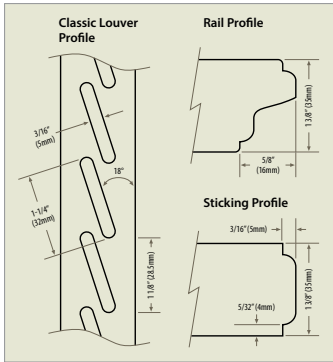

Classic Louver/Louver Clear Pine



Classic Louver/Panel Double Hip Clear Pine



Plantation Louver/Louver Clear Pine



Size	Quantity Per Pallet	Classic Louver/Louver	Classic Louver/Panel Double Hip	Plantation Louver/Louver
		Item #	Item #	Item #
1/6 x 6/8 x 1-3/8	16	3252884	3311350	3232638
2/0 x 6/8 x 1-3/8	32	3252914	3311384	3232662
2/4 x 6/8 x 1-3/8	32	3252930	3311406	3232689
2/6 x 6/8 x 1-3/8	32	3252949	3311414	3232697
2/8 x 6/8 x 1-3/8	32	3252957	3311422	3232700
2/10 x 6/8 x 1-3/8	32	3252973	-	-
3/0 x 6/8 x 1-3/8	32	3252965	3311449	3232727
1/6 x 8/0 x 1-3/8	16	3253210	-	-
2/0 x 8/0 x 1-3/8	32	3253244	-	-
2/4 x 8/0 x 1-3/8	32	3253260	-	-
2/6 x 8/0 x 1-3/8	32	3253279	-	-
2/8 x 8/0 x 1-3/8	32	3253287	-	-
3/0 x 8/0 x 1-3/8	32	3253309	-	-

Bifold

CLEAR PINE DOORS



Features:

- Triple-sanded, furniture-grade finish
- Pre-hinged, ready to install
- Suitable for staining or painting
- Track and hardware included
- Easy to install
- Environmentally friendly, FSC Certified
- 5-year limited warranty

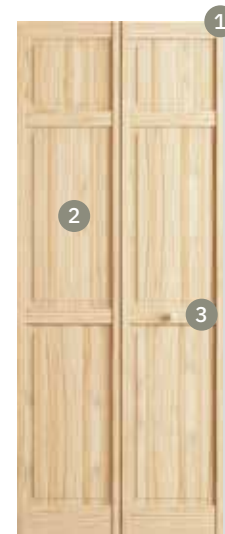

- 1 LVL stiles eliminate warp
- 2 Triple-sanded, furniture-grade finish
- 3 Knob, track and hardware included



*LVL stiles
eliminate warp*

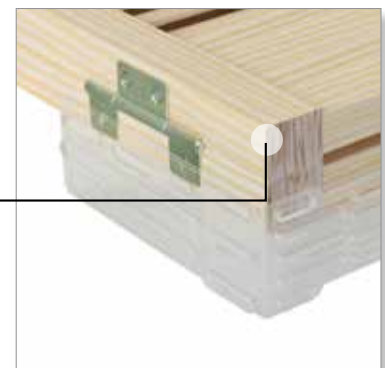

Bifold

CLEAR PINE DOORS



Classic
Louver/Louver
1-1/8"



6 Panel
Colonial,
Double Hip
1-1/8"



Size	Quantity Per Pallet	Classic Louver/Louver 1-1/8"		6 Panel, Colonial Double Hip 1-1/8"	
		Item #	Item #	Item #	Item #
2/0 x 6/8 x 1-1/8	44	3272133	3290425		
2/6 x 6/8 x 1-1/8	44	3272168	3290450		
2/8 x 6/8 x 1-1/8	44	3272176	3290468		
3/0 x 6/8 x 1-1/8	44	3272192	3290484		
4/0 x 6/8 x 1-1/8	22	3113507	3114724		
5/0 x 6/8 x 1-1/8	22	3113515	3114732		
6/0 x 6/8 x 1-1/8	22	3113523	3114759		

Colonial

KNOTTY PINE DOORS



Features:

- 1-3/8" interior wood door
- Suitable for staining or painting
- Environmentally friendly, FSC Certified
- 5-year limited warranty
- All doors are full and square and polyolefin wrapped



- 1 Top & bottom of door is factory-sealed for reliable performance
- 2 No open or putty-filled knots
- 3 Full 3/4" thick panel
- 4 Knotty Pine for genuine rustic appeal

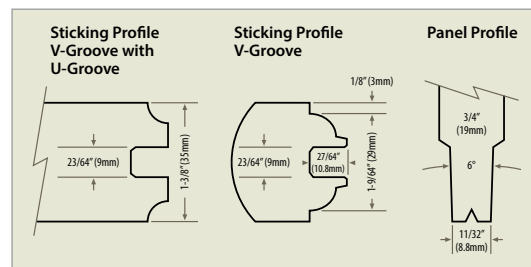
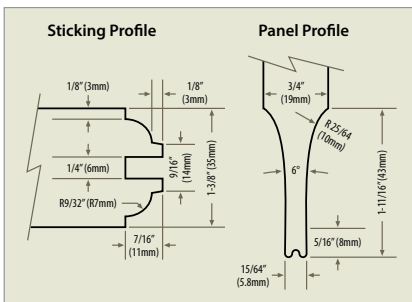

Colonial

KNOTTY PINE DOORS



6 Panel



2 Panel
Arch Top, V-Groove



2 Panel
Arch Top, V-Groove
w/U-Groove



Size	Quantity Per Pallet	6 Panel, Single Hip 3/4" Panel, Knotty	2 Panel, Arch Top V-Groove, Knotty	2 Panel, Arch Top, V-Groove with U-Groove, Knotty
		Item #	Item #	Item #
1/6 x 6/8 x 1-3/8	16	3255964	3337707	3345700
2/0 x 6/8 x 1-3/8	32	3255999	3337731	3345734
2/4 x 6/8 x 1-3/8	32	3256014	3337758	3345750
2/6 x 6/8 x 1-3/8	32	3256022	3337766	3345769
2/8 x 6/8 x 1-3/8	32	3256030	3337774	3345777
3/0 x 6/8 x 1-3/8	32	3256057	3337790	3345793

*Three panel configuration

Barn

KNOTTY PINE DOORS



Features:

- 1-3/8" interior wood door
- Environmentally friendly, FSC Certified
- 5-year limited warranty
- All doors are full and square and polyolefin wrapped



- 1 Top & bottom of door is factory-sealed for reliable performance
- 2 All barn doors have a routed channel along the bottom to fit the floor-mounted door guide

Hardware Options

Each kit includes:

- Track
- Straps
- Floor-Mounted Door Guide
- Stoppers
- Mounting Hardware



*Black
Bent-Strap
Hardware*



*Slate Grey
Straight-Strap
Hardware*

Barn

KNOTTY PINE DOORS



Z-Brace
Rustic



K-Brace
Rustic



Single Panel
V-Groove
Rustic*

* Customized Barn Doors

Using the Single Panel V-Groove door as a base, veneer dressing board can be applied to create a wide variety of panel options. A few samples are shown below.

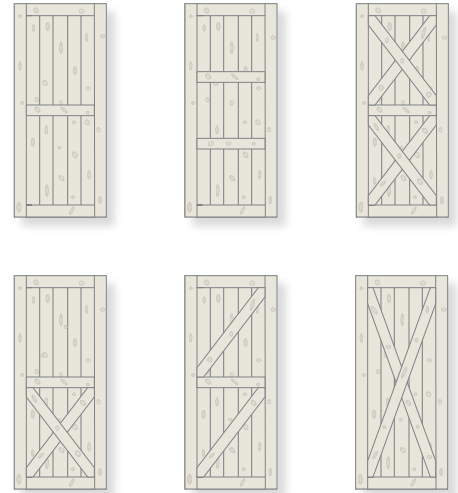

Size	Quantity Per Pallet	Z-Brace Raw	K-Brace Raw	Single Panel V-Groove Raw
		Item #	Item #	Item #
Barn Door Slabs				
2/8 x 7/0 x 1-3/8	1	-	-	0000000
3/0 x 7/0 x 1-3/8	1	3045234	3045366	0000000
3/6 x 7/0 x 1-3/8	1	3045242	-	0000000
Knotty Divider Bar				
0/0 x 0/0 x 0-0/0	1	-	0000000	-
Barn Door Hardware - 80" Track				
Black Finish	1		9041675	
Slate Grey Finish	1		9110574	

Bifold

KNOTTY PINE DOORS



4 Panel, Arch Top
V-Groove
w/U-Groove
1-3/8"

Features:

- Triple-sanded, furniture-grade finish
- Pre-hinged, ready to install
- Suitable for staining or painting
- Johnson 1700 Series track and hardware included
- Easy to install
- Environmentally friendly, FSC Certified
- 5-year limited warranty

- ① Pre-hinged, ready to install
- ② Handle, track and hardware included



Johnson 1700
Series Hardware



Size	Quantity Per Pallet	4-Panel, Arch Top V-Groove with U-Groove Item #
2/0 x 6/8 x 1-3/8	32	3299384
2/6 x 6/8 x 1-3/8	32	3299406
2/8 x 6/8 x 1-3/8	32	3299414
3/0 x 6/8 x 1-3/8	32	3299430
4/0 x 6/8 x 1-3/8	16	3114937
5/0 x 6/8 x 1-3/8	16	3114945
6/0 x 6/8 x 1-3/8	16	3114961

Wood Shims



Features:

- 8" and 12" length by 1-3/8" width
- 100% kiln dried pine
- Easy to cut
- Ideal for professionals and DIY enthusiasts
- Perfect when installing
 - Doors
 - Windows
 - Cabinets
 - Appliances



Individual Shims

8" Shim

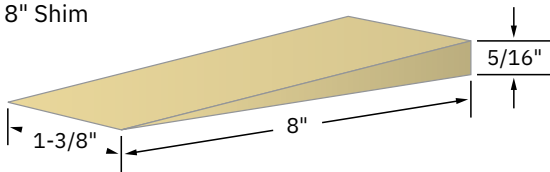

12" Shim

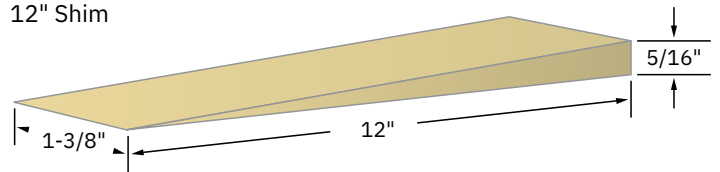

Size	Frameport America Pallet Item #	Boxes per Pallet	Bundles per Box	Shims per Bundle
8"	3658660W	70	36	12
12"	3658678W	30	12	42

Available only in pallet quantities.

About Frameport Doors

Founded in 1979, Frameport has grown to become one of the largest door manufacturers in the world. Frameport owns and manages the forest, sawmill & a state-of-the-art manufacturing facility, creating a vertically integrated operation. Bringing together precision, quality control & flexible production, Frameport offers a wide variety of door styles, sizes & finishes. Both factory and forest are certified by the Forest Stewardship Council, (FSC).

Frameport produces the best stile & rail wood doors available today. With the ever-growing demand for the high quality & aesthetic appeal of real wood doors, the homeowner will continue to look to Frameport to set the standard for value, craftsmanship & design in the door market.

Why Frameport?

The top and bottom of every slab door is factory-sealed with two coats of UV Activated polyacrylic varnish.

Stiles are manufactured with Engineered & LVL technology to eliminate warp and feature solid wood 5/8" Edge Bands for trimming & sizing.

Contoured panels provide a snug fit, preventing them from moving, yet accommodating expansion due to changes in humidity and eliminating panel shifting after finishing.

Louvers are up to 50% thicker for increased strength and no warping.

FSC Certified Forest and Factory



9484 Old Bailes Road, Suite 200
Ft. Mill, SC 29707

Phone: (803) 547-0891

Fax: (803) 547-0844

www.frameportamerica.com